



Data as the key – understanding all the options for business improvement Panel

Mark Brommeyer, Manager Supply Chain, NEHTA

Richard Bowen, Manager Data Systems and Reporting, HPV

Steve Capel, Director Global CRM Process Excellence, Covidien

Mark Wasmuth, CEO GMDN Agency

Jay Crowley, Senior Advisor for Patient Safety, US FDA





Contentions

Good Data can be seen:

- Across the spectrum of Supply Chain, i.e. from product manufacture right down to when the product meets the patient
- For supply chain efficiencies, procurement benefits and clinical improvements – both real and potential
- As electronically trustworthy, i.e. unique and unambiguous product and location identification, will lead to more lean processes and procurement benefits
- As improving the evidence base – better data mining for product track, trace and recall, clinical and safety improvements
- As the nirvana of international healthcare supply chain goodness – ensuring we leave something for our grand children



Good Data is Good Procurement

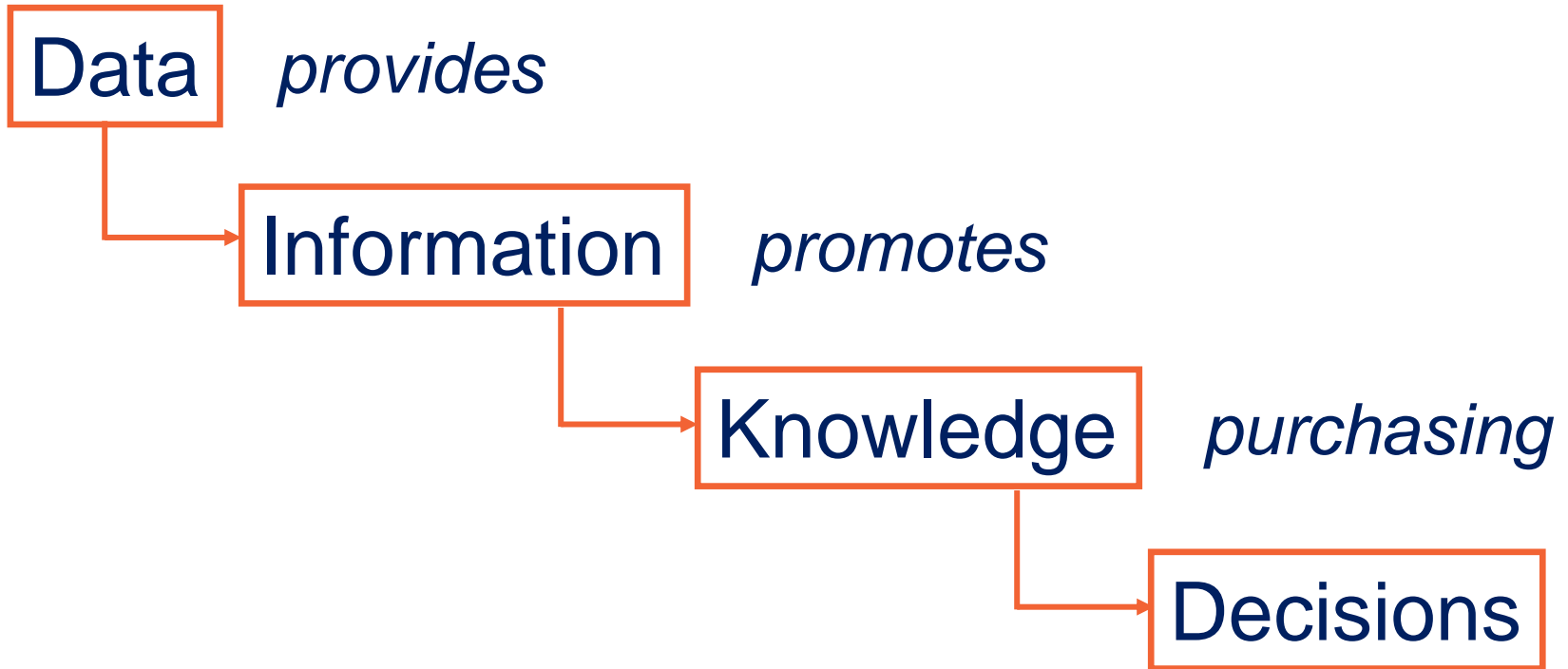



Agenda

1. Each panellist presents a seven (7) minute **'Making Their Case'** presentation
2. **Delegates** – please take note of questions, contentions and opportunities you'd like to explore with the Panel
3. Chair will open the floor and moderate **questions** to the Panel
4. Please be ready to be **interactive**, challenge thinking and propose ideas for discussion
5. We'll finish off with Supply Chain **Karaoke** 😊





Steve Capel

Setting the Scene: Data Game





Richard Bowen

Manager Data Systems
and Reporting

Health Purchasing Victoria





Place Holder

- Richard Bowen, Manager Data Systems and Reporting, HPV
- Good stuff...





Steve Capel

Covidien

Director Global CRM
Process Excellence





Why Global Data Synchronization ?

My mum and dad like to travel..
Over the last few years they have

- U.S
- Portugal
- Italy
- Egypt
- Australia (via Hong Kong)
- New Zealand
- Spain

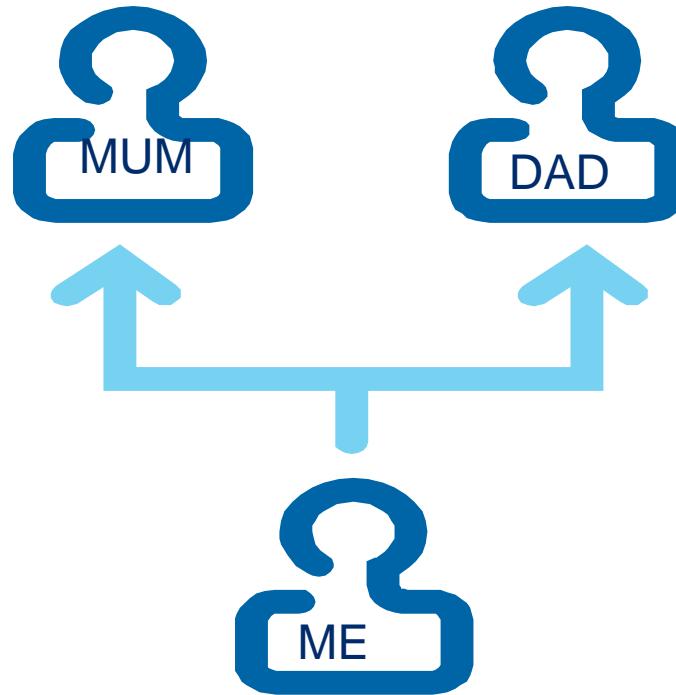



Why Global Data Synchronization ?

My mum and dad are 69 and 73 respectively. There is no stopping them. However.....Both have a dependency on Drugs and Medical Devices

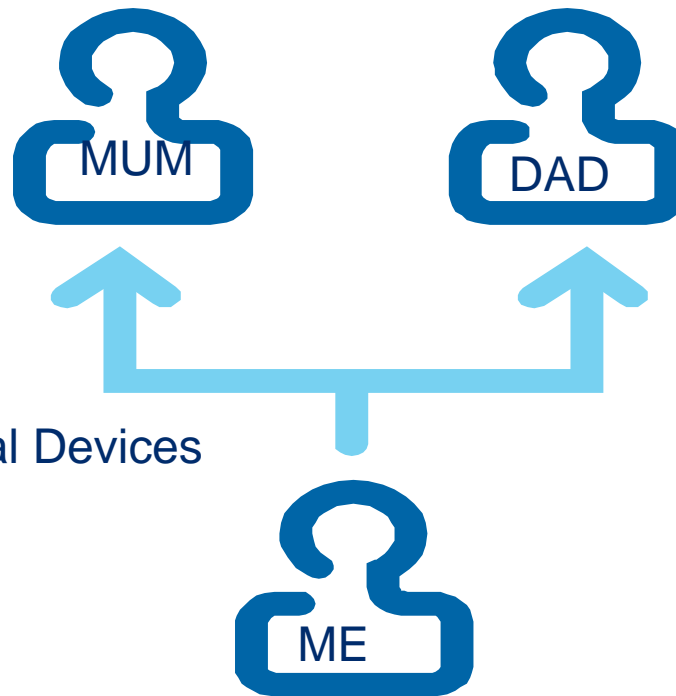



Ramapril 1.25mg
Furosemide 20mg
Ranitidine 20mgx2
Aspirin 75mg



Nufedipine 20mgx2
Metropolo 50mgx2
Bendroflumethiazide
2.5 mg daily
Simvastatin 20mg
Aspirin 75mg
Loferamide 2 daily
Omeprazole 20mg
Holister Stoma bag



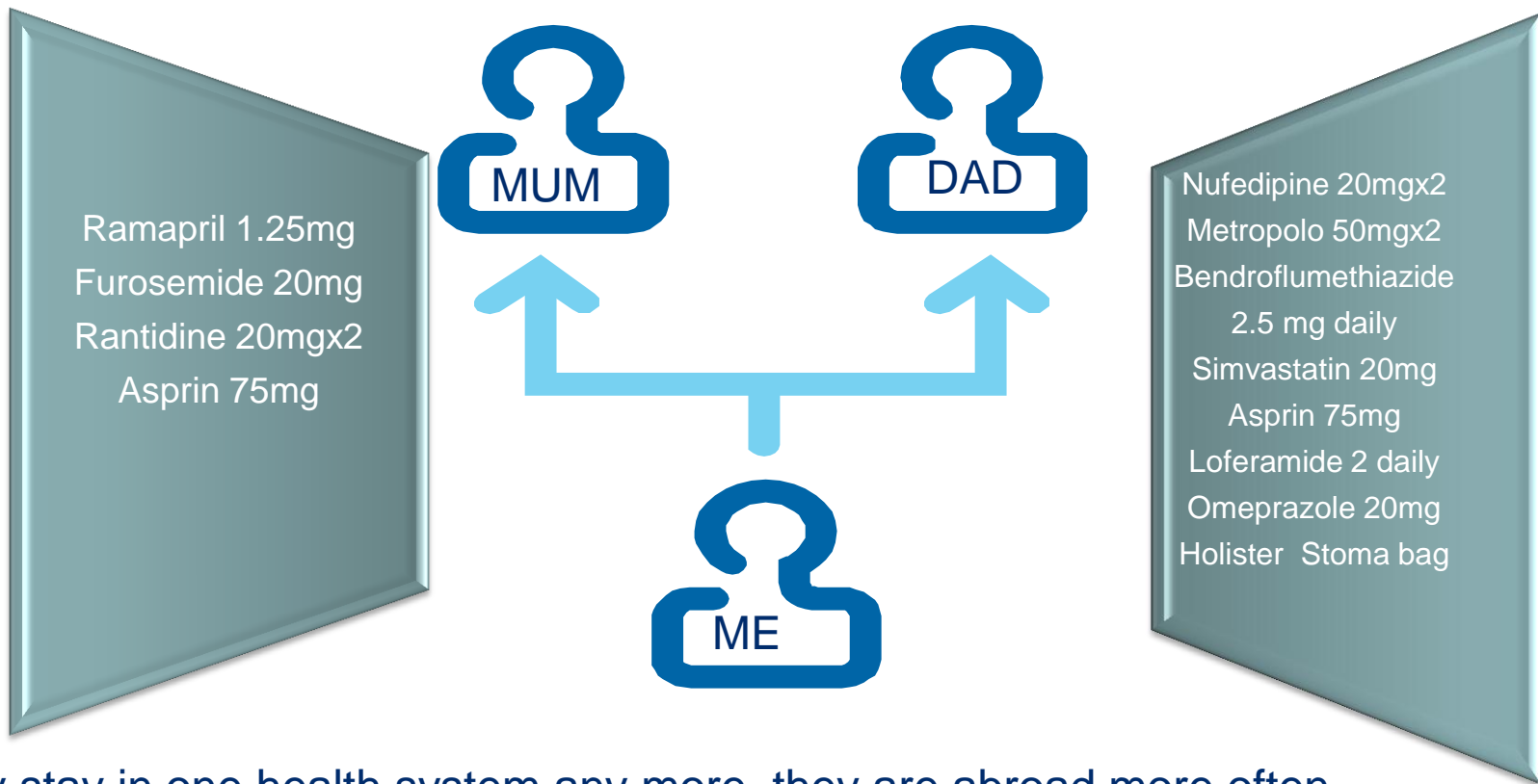

People rarely stay in one health system any more, they are abroad more often and later in life. GDSN in my view will be one of the enablers to ensure that people can travel safely in the knowledge that consistent and unambiguous product information is available if they need to attend hospital or need to purchase drugs or devices abroad

Why is this good for business improvement ?

Because we are all committed to better patient outcomes.....



Contact Details

Steve Capel

Covidien

Steve.capel@covidien.com

+44 777 552 0123





Mark Wasmuth

Chief Executive Office
GMDN Agency



Global Medical Device Nomenclature

GMDN

- **G**lobal – It will be a requirement!
- **M**Ds + hospital inventory (not drugs!)
- **N**aming system + translations

- Many MD manufacturers already have the necessary GMDN codes for their products
- Hospitals now need to use the GMDN

GMDN Term Structure

Each GMDN Term consists of 3 data elements:

- ❑ **Term Name:** Insulin syringe, fixed-needle
- ❑ **Definition:** A device consisting of a small, calibrated, hollow barrel (cylinder) and a moveable plunger with a permanently-attached needle (usually capped for user protection) that is used to administer an injection of insulin to a patient subcutaneously...
- ❑ **Code:** 38501

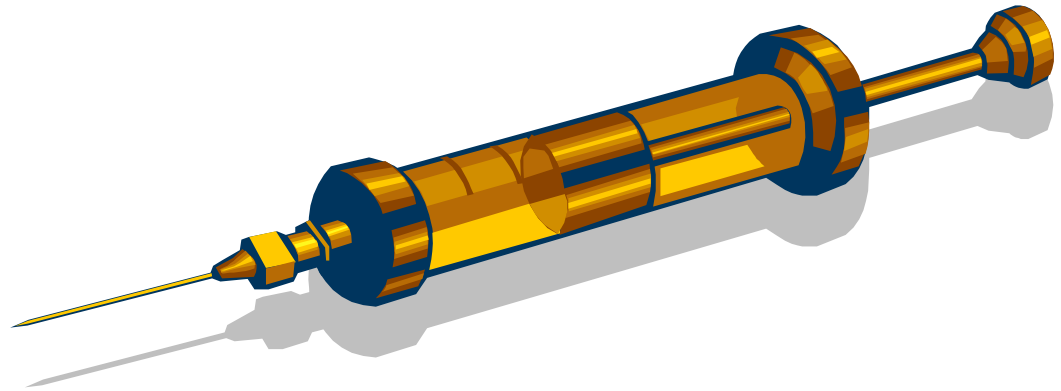

GMDN working with UDI

**Individual Device Type
= Unique Device ID**

Hudson Co.

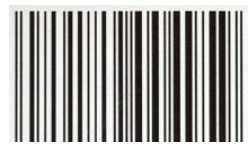
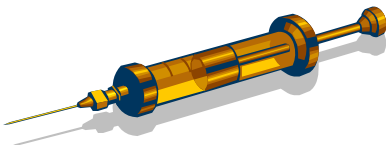

1234567890

**Generic Device Group (family)
= GMDN Term**

Hudson Co.



1234567890

Brooks Ltd



0987654321

Woods Inc.



3234567890

G•M•D•N

Use the GMDN to find 'missing' stock

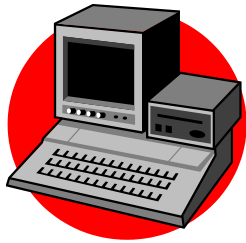

GMDN	Make	UDI	Stock	Location
38501	Hudson	1234567890	1	Ward C



Stock Control Database

Hudson

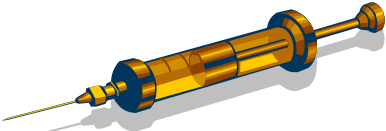

1234567890

20 Needed in Ward C

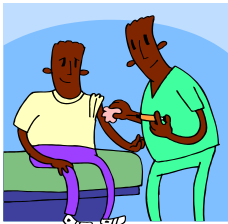

Use the GMDN to find 'missing' stock

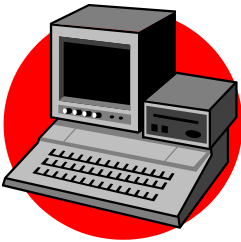

GMDN	Make	UDI	Stock	Location
38501	Hudson	1234567890	1	Ward C
38501	Woods	3234567890	2	Ward E
38501	Brooks	0987654321	100	Ward H

Stock Control Database

Hudson

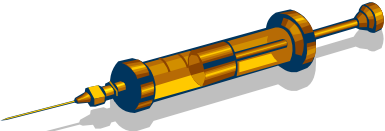

1234567890

20 Needed in Ward C



100 Located in Ward H

Brooks

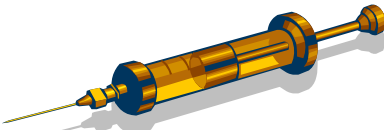

0987654321



Jay Crowley

Senior Advisor for
Patient Safety
US FDA



“The inadequacy of the current postmarketing surveillance system and the resulting lack of data make it impossible to confidently draw broad conclusions about the safety and effectiveness of products that are on the market.

The lack of standardization in clinical and device-specific data among existing non-FDA data sources and insufficient detail in administrative and clinical health records impede the evaluation of the performance of medical devices.”

IOM Report *Medical Devices and the Public's Health: The FDA 510(k) Clearance Process at 35 Years*

Device Information Lifecycle

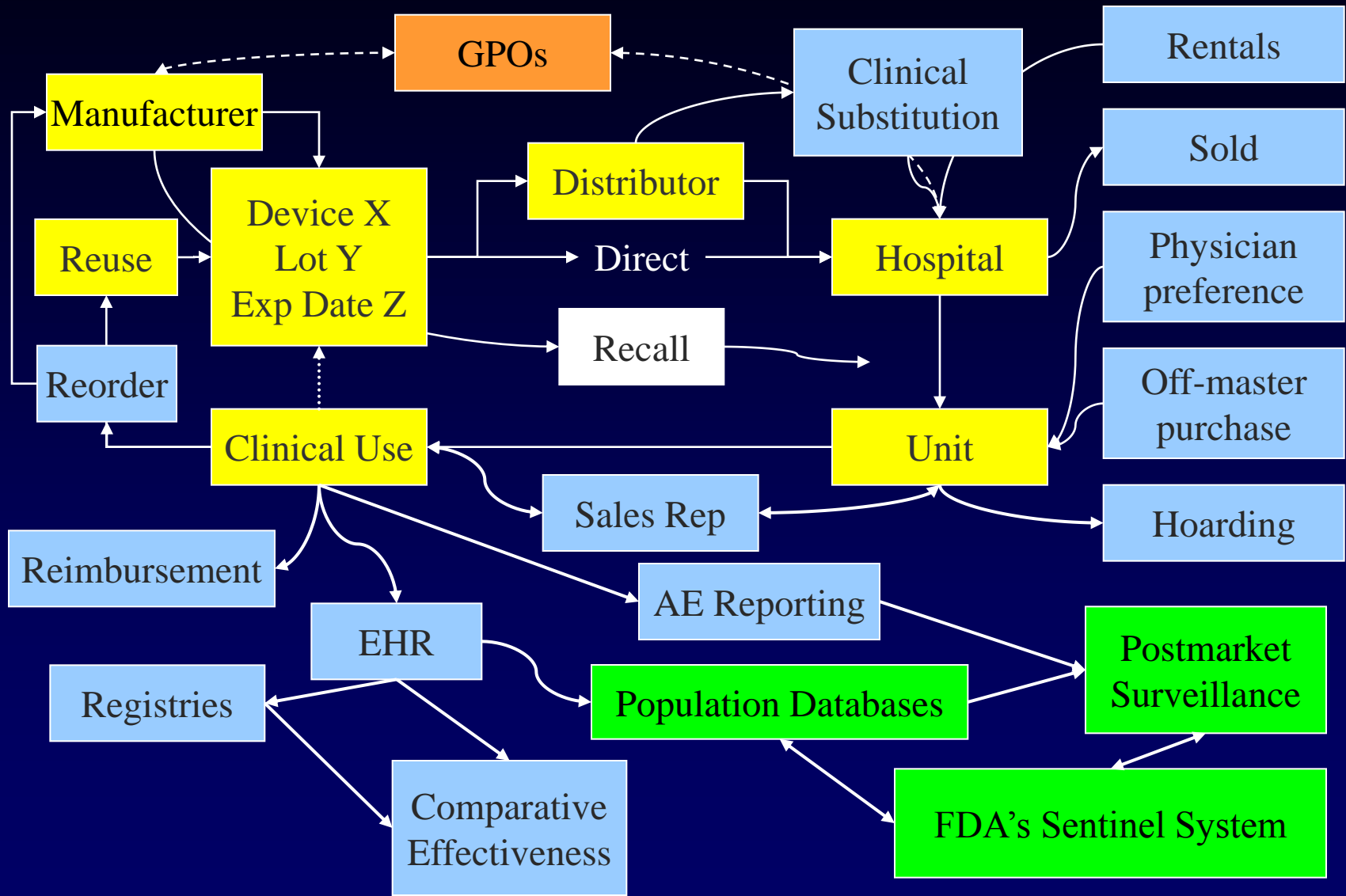

Why do we need UDI?

- Reduce device-related medical errors
- Improve efficiency and effectiveness of device recalls
- Enhance accuracy of AE reports and FDA's ability to aggregate and summarize these reports
- Improve device postmarket surveillance (eg Sentinel)
- Address compatibility and interoperability issues
- Allow for global track and trace systems and better identification of counterfeit devices
- Improve import review
- Allow for identification of similar devices in cases of disaster/terror preparation and shortages/substitutions

Medical Device Recalls

“Our preliminary analysis found that firms initiated about 700 recalls per year. However, we found that firms were unable to correct or remove all recalled devices even though subject to the highest risk or Class 1 recalls...”

GAO Healthcare director Marcia Crosse

Clinical Impact of UDIs

- Scanning devices at facility entry and maintaining UDI in the hospital information system would provide traceability (e.g., recalls)
- Scanning the device when it is used in a patient would provide documentation of use
- Bedside scanning for device verification – e.g., latex allergy, MRI compatibility, recalled devices
- UDI Database provides national catalogue of ALL devices – find appropriate device, find comparable devices in cases of disaster or shortages/substitutions

Why do we need UDI in EHRs?

- The National Medical Device Registry – “linking” (incorporating) UDIs to health-related electronic records to “facilitate analysis of postmarket safety and outcomes data.”
- Facilitate AE reporting and assessing device-related adverse events and product problems; recall tracking
- Development of “Virtual Registries” (longitudinal tracking) to assess the risk/benefit and comparative safety/effectiveness in large populations
- Conduct of active surveillance for earlier detection of safety signals.

FDA Amendments Act of 2007

September 27, 2007, the FDAAA signed into law:

The Secretary shall promulgate regulations establishing a unique device identification system for medical devices requiring the label of devices to bear a unique identifier, unless the Secretary requires an alternative placement or provides an exception for a particular device or type of device. The unique identifier shall adequately identify the device through distribution and use, and may include information on the lot or serial number.

Unique Device Identification

www.fda.gov/UDI

Email: cdrhudi@fda.hhs.gov



Let the Games Begin...

1. **Delegates** – please now propose the questions, contentions and opportunities you'd like to explore with the Panel:
 - **Richard** Bowen, Manager Data Systems and Reporting, HPV
 - **Steve** Capel, Director Global CRM Process Excellence, Covidien
 - **Mark** Wasmuth, CEO GMDN Agency
 - **Jay** Crowley, Senior Advisor for Patient Safety, US FDA
2. Please be ready to be **interactive**, challenge thinking and propose ideas for discussion
3. Please state your **name, role, organisation** and **country**
4. **Who's first?**





Contact Details

mark.brommeyer@nehta.gov.au

r.bowen@hpv.org.au

steve.capel@covidien.com

mark.wasmuth@gmdnagency.org

Jay.Crowley@fda.hhs.gov

